



T1

Battery Floor Scrubber

English **EN**

Operator Manual

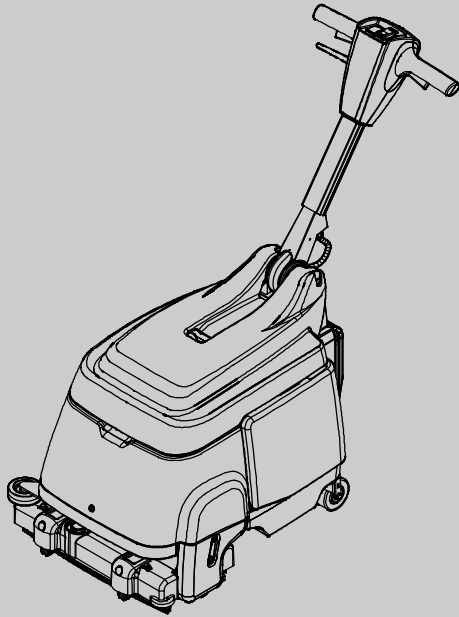

Models:

9008636 - T1, AGM Battery

9008639 - T1, Lithium-ion Battery

CE



For the latest Parts manuals and other language Operator manuals, visit:

www.tennantco.com/manuals

9008591
Rev. 01 (07-2016)



This manual is furnished with each new model. It provides necessary operation and maintenance instructions.



Read this manual completely and understand the machine before operating or servicing it.

This machine will provide excellent service. However, the best results will be obtained at minimum costs if:

- The machine is operated with reasonable care according to instructions provided.
- The machine is maintained regularly - per the machine maintenance instructions provided.
- The machine is maintained with manufacturer- supplied or equivalent parts.

To view, print or download manuals online visit www.tennantco.com/manuals

Use the Parts Manual to order replacement parts.

UNCRATING MACHINE: Carefully check carton for signs of damage. Report damages at once to carrier.



PROTECT THE ENVIRONMENT

Please dispose of packaging materials and old machine components in an environmentally safe way according to local waste disposal regulations.



Always remember to recycle.

MACHINE DATA

Please fill out at time of installation for future reference.

Model No. - _____

Serial No. - _____

Sales Rep. - _____

Sales Rep. phone no. - _____

Customer Number - _____

Installation Date - _____

TABLE OF CONTENTS

SAFETY PRECAUTIONS	3
SAFETY LABELS	4
MACHINE COMPONENTS	5
MACHINE SETUP	6
INSTALLING BRUSH	6
FILLING SOLUTION TANK	6
MACHINE OPERATION	7
PRE- OPERATION	7
SCRUBBING FLOORS	7
BATTERY DISCHARGE INDICATOR	9
CIRCUIT BREAKERS	9
HOUR METER	9
BATTERY	9
CHARGING BATTERY:	10
REPLACING BATTERY:	11
MACHINE MAINTENANCE	12
AFTER EACH USE	12
AFTER WEEKLY USE	12
VACUUM HOSE MAINTENANCE	13
SQUEEGEE BLADE REPLACEMENT	14
TRANSPORTING MACHINE	14
STORING MACHINE	14
TROUBLESHOOTING	15
MACHINE SPECIFICATIONS	16
MACHINE DIMENSIONS	16

TENNANT N.V.
Industrielaan 6 5405 AB
P.O. Box 6 5400 AA Uden- The Netherlands
 Europe@tennantco.com www.tennantco.com

Specifications and parts are subject to change without notice. Original Instructions. Copyright © 2011-2016 Tennant Company. All rights reserved.

SAFETY PRECAUTIONS

This machine is intended for commercial use. It is designed exclusively to scrub hard floors in an indoor environment and is not constructed for any other use. Use only recommended brushes and commercially approved floor cleaners intended for machine application.

All operators must read, understand and practice the following safety precautions.

The following warning alert symbol and the "FOR SAFETY" heading are used throughout this manual as indicated in their description:

⚠ WARNING: To warn of hazards or unsafe practices which could result in severe personal injury or death.

FOR SAFETY: To identify actions which must be followed for safe operation of equipment.

The following safety precautions signal potentially dangerous conditions to the operator or equipment.

⚠ WARNING: Fire Or Explosion Hazard

- Do Not Use or Pick Up Flammable Materials
- Only Use Commercially Available Floor Cleaners Intended for Machine Application.
- Do Not Use Near Flammable Liquids, Vapors or Combustible Dusts.
- Batteries Emit Hydrogen Gases. Keep Machine Away from Heat, Sparks and Open Flame.

This machine is not equipped with explosion proof motors. The electric motors will spark upon start up and during operation which could cause a flash fire or explosion if machine is used in an area where flammable vapors/liquids or combustible dusts are present.

⚠ WARNING: Electrical Hazard

- Do Not Charge Batteries with Damaged Cord. Do Not Modify Plug.

If the charger cord is damaged or broken, it must be replaced by the manufacturer or its service agent or a similarly qualified person in order to avoid a hazard.

- Disconnect Battery Cable and Charger Cord Before Servicing.

⚠ WARNING: Spinning Brush. Keep Hands Away.

⚠ WARNING: Electrical Shock Hazard. Do Not Use Outdoors. Do Not Expose To Rain/Moisture. Store Indoors.

FOR SAFETY:

1. Do not operate machine:
 - Unless trained and authorized.
 - Unless operator manual is read and understood.
 - Unless mentally and physically capable of following machine instructions.
 - In an area where flammable vapors/liquids or combustible dusts are present.
 - Outdoors.
 - If not in proper operating condition.
 - If battery emits an unusual odor. Move machine to a ventilated area and contact Customer Service immediately.
 - If battery is leaking any substance. Avoid contact with battery substance and contact Customer Service immediately.
 - If battery becomes excessively hot. Disconnect battery charger. Move machine to a ventilated area and contact Customer Service immediately.
2. Before operating machine:
 - Make sure all safety devices are in place and operate properly.
 - Wear non-slip shoes.
 - Follow safety guidelines concerning wet floors.
 - Follow mixing, handling and disposal instructions on chemical containers.
3. When operating machine:
 - Report machine damage or faulty operation immediately.
 - Do not allow children to play on or around machine.
 - If foam or liquid begins to leak from machine, immediately shut off machine.
 - Do not operate on inclines.
4. Before leaving machine:
 - Stop on level surface.
 - Turn the main power switch to the off position.
5. When servicing machine:
 - Stop on level surface.
 - Turn the main power switch to the off position.
 - Do not tilt machine back unless main power switch is turned off and tanks are empty.
 - Disconnect battery connections before working on machine.
 - Do not disconnect the charger's DC cord from the machine's receptacle when the charger is operating. Arcing may result. If the charger must be interrupted during charging, disconnect the AC power supply cord first.

- The use of incompatible battery chargers may damage battery and potentially cause a fire hazard.
- Wear protective gloves and eye protection when handling batteries or battery cables.
- Avoid contact with battery acid.
- Use manufacturer supplied or approved replacement parts.
- All repairs must be performed by a qualified service person.
- Avoid moving parts. Do not wear loose clothing or jewelry
- Do not power spray or hose off machine. Electrical malfunction may occur.
- Do not modify the machine from its original design.

6. When transporting machine:
- Turn the main power switch to the off position.
 - Get assistance or use a mechanical lift when lifting machine.
 - Do not wheel up or down stairs.
 - Do not tilt on rear casters or wheels.
 - Use tie-down straps to secure machine when transporting by vehicle.

SAFETY LABELS

The safety labels appear on the machine in the locations indicated. Replace labels if they are missing or become damaged or illegible.



FOR SAFETY: Do not operate machine unless operation manual is read and understood.



! WARNING: Spinning Brush. Keep Hands Away. Turn Off Power Before Working On Machine.



! WARNING: Fire or Explosion Hazard. Do not use flammable liquids. Do not pick up flammable liquids



! WARNING: Electrical Hazard. Do not use with damaged cord. Unplug cord before servicing.



Lithium-ion Battery Model

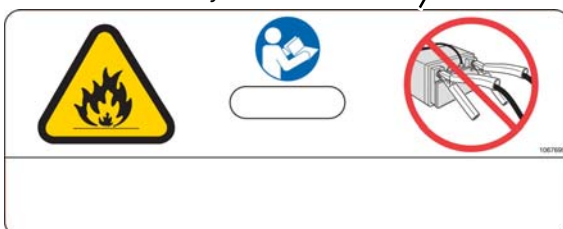

FOR SAFETY: When servicing machine, the use of incompatible battery chargers may damage battery and potentially cause a fire hazard.

MACHINE COMPONENTS

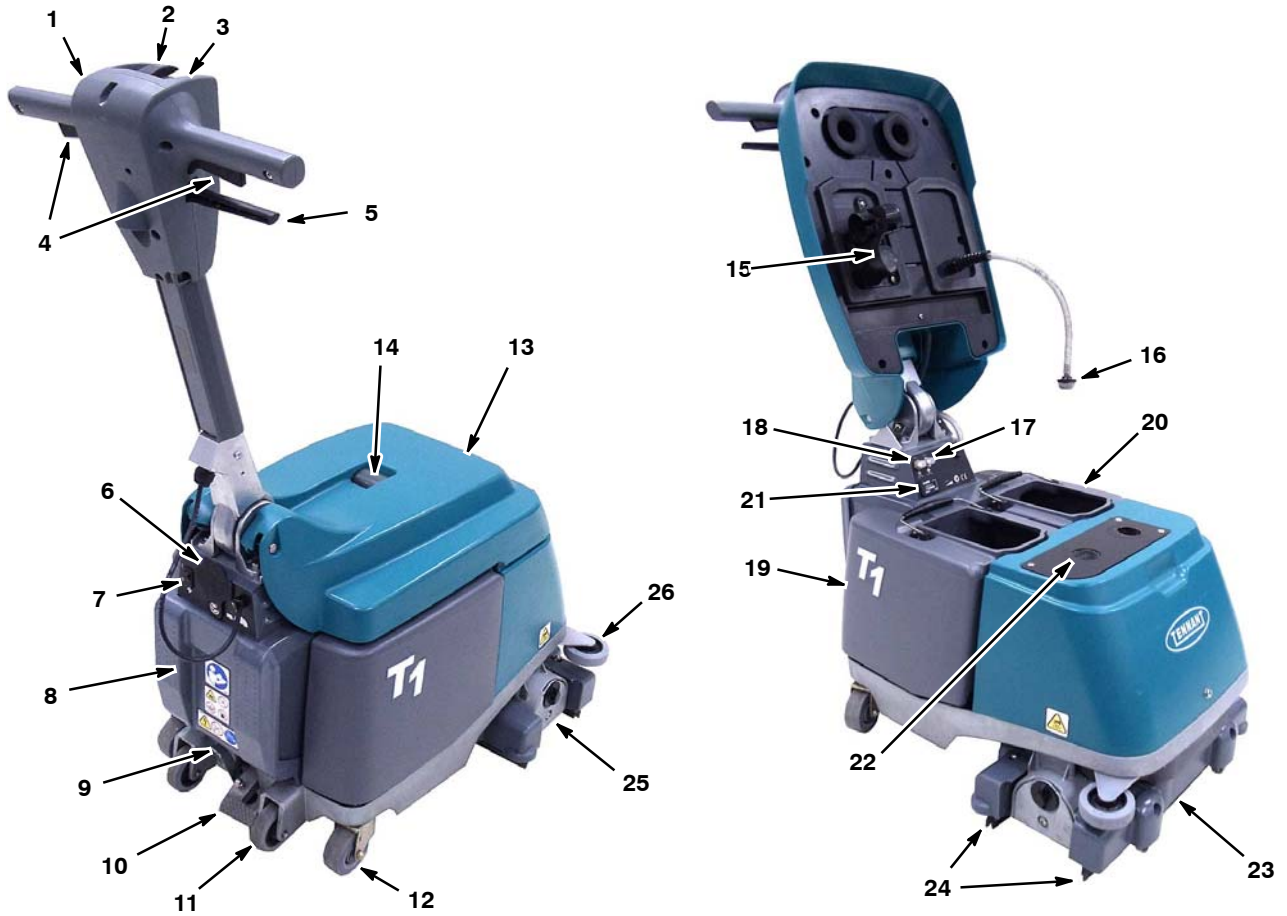

- 1. Adjustable Control Handle
- 2. Main Power ON/OFF Switch
- 3. Battery Discharge Indicator
- 4. Start Triggers
- 5. Handle Adjustment Lever
- 6. Battery Charger Connector
- 7. Vacuum Power ON/OFF Switch
- 8. Battery Compartment
- 9. Transport Release Pedal
- 10. Scrub Head Lift Pedal
- 11. Curb Climbing Wheels
- 12. Main Wheels
- 13. Tank Cover

- 14. Recovery Window
- 15. Vacuum Shut-Off Float
- 16. Solution Tank Screen
- 17. Brush Circuit Breaker Button
- 18. Vacuum Circuit Breaker Button
- 19. Recovery Tank
- 20. Solution Tank
- 21. Hour meter
- 22. Vacuum Intake Screen
- 23. Scrub Head
- 24. Squeegee Blades
- 25. Brush Housing
- 26. Bumper Wheel

MACHINE OPERATION SYMBOLS

Power On	Battery Discharge Indicator	Vacuum Circuit Breaker	Battery Charging
Power Off	Vacuum	Brush Circuit Breaker	2% (1°) Maximum Grade Level

MACHINE SETUP

INSTALLING BRUSH

1. Turn the main power switch to the (O) off position.

FOR SAFETY: Before servicing machine turn the main power switch to the off position.

2. Raise the scrub head to the transport position by stepping on the scrub head lift pedal (Figure 1).



FIG. 1

3. Remove the brush idler plate from the brush base. Turn the idler plate locking knob counter-clockwise to remove (Figure 2).

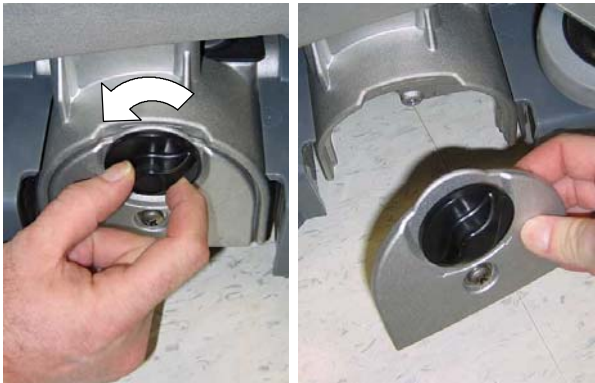

FIG. 2

4. Connect the slotted end of the brush to the drive hub (Figure 3).

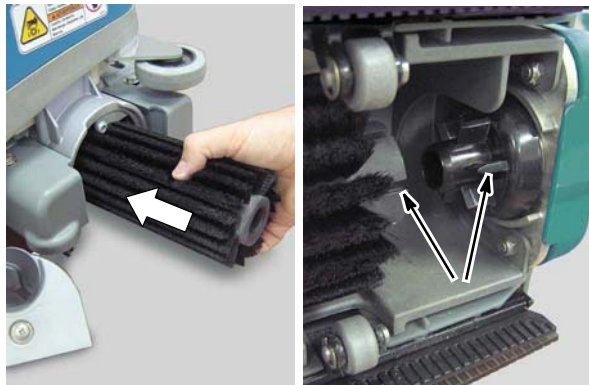

FIG. 3

5. Connect the idler plate to the brush and reinstall the idler plate. Make sure the idler plate tabs engage the brush base and that the locking knob is secure (Figure 4).



FIG. 4

NOTE: If storing the machine for an extended period, raise the scrub head to the transport position to prevent a flat spot developing on the brush.

FILLING SOLUTION TANK

1. Remove the solution tank from machine and carry tank to water source (Figure 5).



FIG. 5

2. Fill the solution tank with 9.5 L of clean water (50°C maximum temperature). Do not fill beyond the "MAX" fill label (Figure 6). Partially fill if unable to lift a full tank. A full tank weighs 12 kg.



FIG. 6

ATTENTION: When refilling solution tank always empty the recovery tank.

ATTENTION: Do not use the recovery tank to fill the solution tank. Dirt from the recovery tank may cause damage to the solution pump.

3. Pour an approved low foaming cleaning detergent into the solution tank according to the mixing instructions on the bottle.

ATTENTION: Only use approved cleaning detergents. Machine damage due to improper detergent usage will void the manufacturer's warranty.

Contact your dealer for recommended cleaning detergents.

FOR SAFETY: Follow mixing, handling and disposal instructions on detergent containers.

⚠ WARNING: Fire Or Explosion Hazard. Do Not Use Flammable Materials. Only Use Commercially Available Floor Cleaners intended for machine application.

4. Replace the solution tank on the machine. Submerge the solution tank screen into solution and close the cover (Figure 7).

ATTENTION: Be careful to not splash water on the vacuum motor intake screen. Vacuum motor failure may result.



FIG. 7

MACHINE OPERATION

FOR SAFETY: Do not operate machine unless operator manual is read and understood.

PRE- OPERATION

1. **IMPORTANT:** To prevent vacuum system from clogging, sweep and dust-mop floor.
2. Make sure battery is charged.
3. Check that the brush and squeegee blades are installed.

SCRUBBING FLOORS

FOR SAFETY: Before Operating machine, follow safety guidelines concerning wet floors.

⚠ WARNING: Fire or Explosion Hazard, Do Not Use or Pick Up Flammable Materials.

⚠ WARNING: Spinning Brush. Keep Hands Away.

1. Pull the handle adjustment lever and adjust the handle to a comfortable operating height (Figure 8). Release the lever to lock the position.



FIG. 8

2. Lower the scrub head to the floor by stepping on the transport release pedal (Figure 9).



FIG. 9

3. Press the main power switch to the on (I) position (Figure 10).



FIG. 10

- Press the vacuum switch to the on (I) position (Figure 11).



FIG. 11

- To begin scrubbing, pull the start triggers and push or pull the machine in either direction (Figure 12).



FIG. 12

- To stop scrubbing, release the triggers and continue to move the machine to pick up all solution.
- When scrubbing, view the water pickup from the recovery window (Figure 13). When the water pickup stops, stop scrubbing and empty the recovery tank.

ATTENTION: When refilling solution tank always empty the recovery tank.

NOTE: To protect the vacuum motor from potential damage, the cover is equipped with a vacuum shut-off float that will stop water pickup when the recovery tank becomes full (Figure 14). A sudden change in vacuum motor sound will occur when this happens.



FIG. 13



FIG. 14

ATTENTION: Check for excessive foam in the recovery tank. Foam may not activate the shut-off float. Foam intake may damage machine and void the manufacturer's warranty.

FOR SAFETY: When operating machine, if foam or liquid begins to leak from machine, immediately shut off machine.

- For heavily soiled areas, use the double scrub method. First scrub the soiled area with the vacuum switch turned off then scrub the area a second time with vacuum switch turned on (Figure 15).

FOR SAFETY: Before Operating machine, follow safety guidelines concerning wet floors.



FIG. 15

- To transport machine from one room to another, raise the scrub head to the transport position and push the machine forward (Figure 16).

DO NOT tilt machine on the rear wheels. Only use rear wheels to transport machine up and down a curb.



FIG. 16

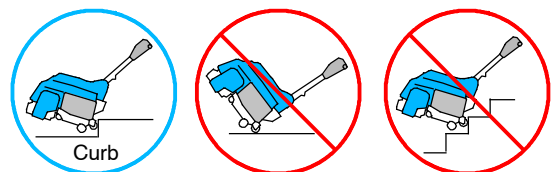

FOR SAFETY: When transporting machine, do not wheel up or down stairs. Get assistance or use a mechanical lift when lifting machine.

BATTERY DISCHARGE INDICATOR

The battery discharge indicator displays the charge level of the battery (Figure 17).

When the discharge level reaches the red zone, the machine will automatically shut down (Figure 17). Recharge battery at this time (See **CHARGING BATTERY**).

To prolong battery life, do not leave battery discharged for a lengthy period.



FIG. 17

CIRCUIT BREAKERS

The machine is equipped with two resettable circuit breakers to protect the brush and vacuum motors from damage (Figure 18). If the brush or vacuum become obstructed, the circuit breaker will trip. To reset circuit breaker, turn off the main power switch, remove the obstruction then reset the circuit breaker button (Figure 18). If the circuit breaker does not reset immediately, allow the machine to cool.

FOR SAFETY: Before removing obstruction turn the main power switch to the off position.



FIG. 18

HOURLY METER

The hour meter records the number of total hours the machine has been powered on. Use the hour meter to record machine use and service history (Figure 19).



FIG. 19

BATTERY

Your machine is equipped with either a 12V lithium-ion battery or a 12V sealed AGM lead acid battery. The battery does not require any maintenance other than routine charging.



FIG. 20

To convert a machine with an AGM battery to a Lithium-ion battery or a Lithium-ion battery to an AGM battery, a battery conversion kit is required.

Do not exchange battery types unless conversion kit is installed, machine and battery damage may result.

- 9008689 - AGM to Lithium-ion Battery Conversion Kit
- 9008688 - Lithium-ion to AGM Battery Conversion Kit

CHARGING BATTERY:

Only use the battery charger that is approved and supplied by Tennant (Fig. 21).

FOR SAFETY: When servicing machine, the use of incompatible battery chargers may damage battery and potentially cause a fire hazard.



Lithium- ion Battery Model - HB250- 12 Battery Charger AGM Battery Model - CBHD1- 12 Battery Charger

FIG. 21

For battery charger operating instructions, refer to the User's Manual supplied with the battery charger. The charger's User's Manual should remain with the battery charger at all times.

For Lithium- ion battery models, recharge battery after every use even if only slightly discharged.

For AGM battery models, only recharge battery after 20 minutes of use or more. This will prolong the life of the battery.

FOR SAFETY: Do not operate machine if battery emits an unusual odor, leaks any substance or becomes excessively hot.

To Charge Battery:

1. Transport the machine to a ventilated area.
2. Park the machine on a flat, dry surface and turn the main power switch to the off position.
3. Remove the charging receptacle cover at the rear of the machine and plug the charger's DC cord into the receptacle (Figure 22).

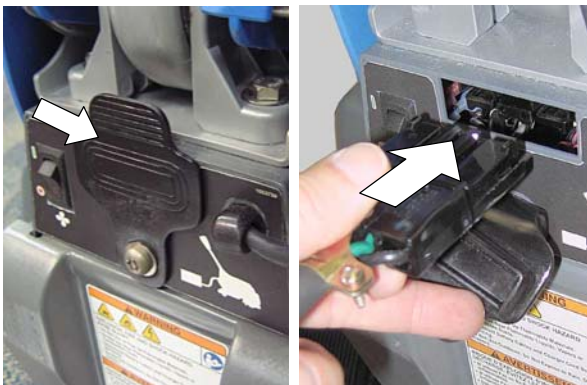

FIG. 22

4. Connect the charger's AC power supply plug into a properly grounded receptacle.

NOTE: The machine will not operate once the battery charger is connected.

5. The charger will start automatically and begin the charging process until battery is fully charged. The charger's three LEDs will display solid when fully charged.

Maximum Charging Cycle:
 3 hours - Lithium- ion battery
 8 hours - AGM battery

NOTE: If charger is left plugged in after charging is complete, the charger will go into a maintenance mode and keep battery fully charged.

6. After charging cycle has completed, turn charger off by disconnecting the AC power supply cord from electrical outlet. Then unplug DC charger plug from machine (Figure 23).

FOR SAFETY: When servicing machine, do not disconnect the charger's DC cord from the machine's receptacle when the charger is operating. Arcing may result. If the charger must be interrupted during charging, disconnect the AC power supply cord first.

7. Replace the charging receptacle cover on the machine (Figure 23).



FIG. 23

REPLACING BATTERY:

FOR SAFETY: When servicing machine, wear protective gloves and eye protection when handling batteries and battery cables. Avoid contact with battery acid.

NOTE: Make sure the battery type is the same as the one you are replacing. To convert from an AGM to Lithium-ion or from Lithium-ion to AGM a Battery Conversion Kit is required.

1. Park the machine on a level surface and turn the main power switch to the off position.
2. Remove battery compartment cover from machine by removing two screws at bottom of cover (Fig. 24).



FIG. 24

3. Unfasten the battery support strap. Disconnect the red positive (+) cable first then black negative (-) cable from battery. Carefully remove battery from machine.

4. Install new battery (Figure 25). Connect the black cables to negative (-) terminal first then red cables to positive (+) terminal. Secure battery with support strap.

On a lithium-ion battery, connect the female plug from battery to machine harness. This plug is the communication cable to the battery management system. The second plug (male) on the battery is not used.

AGM Battery



Lithium-ion Battery

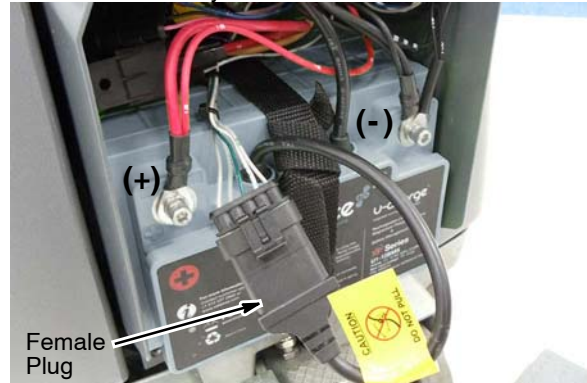
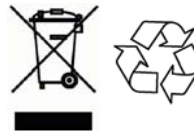

FIG. 25

5. Dispose of old battery in an environmentally safe way according to your local regulations. Contact your local regulatory authorities for proper transporting and disposal instructions. Help preserve the environment – Recycle!



MACHINE MAINTENANCE

To keep the machine in good working condition, simply follow the machine's maintenance procedures.

FOR SAFETY: Before performing any maintenance procedures turn the main power switch to the off position.

FOR SAFETY: When servicing machine, all repairs must be performed by a qualified service person.

AFTER EACH USE

1. Empty the recovery tank and thoroughly rinse with clean water (Figure 26).



FIG. 26

2. Recharge the battery (See CHARGING BATTERY) (Figure 27).



FIG. 27

3. Raise the scrub head to the transport position to prevent flat spot on brush (Figure 28).



FIG. 28

AFTER WEEKLY USE

1. Clean the vacuum shut-off float with damp cloth (Figure 29) and remove any debris buildup from vacuum intake screen (Figure 30).

ATTENTION: Be careful not to get water in vacuum intake screen, vacuum damage may result.

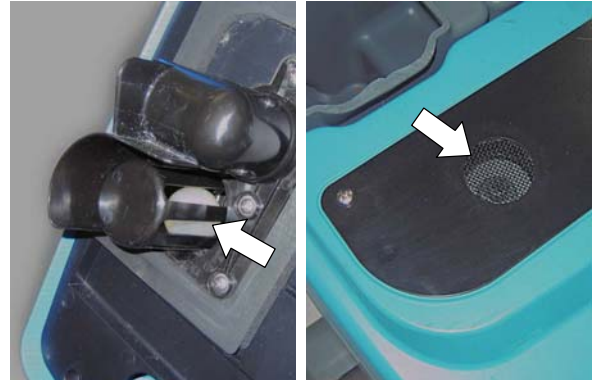

FIG. 29

FIG. 30

2. Remove the brush and check for entangled debris (Figure 31). Replace brush if damaged or worn.



FIG. 31

3. Tilt the machine back and clean the underside of the scrub head (Figure 32).

FOR SAFETY: Before tilting machine, turn the main power switch to the off position and empty tanks.



FIG. 32

- Wipe the squeegee blades (Figure 33). Replace the blades if worn or damaged. Remove any clogged debris inside both inlet openings.

FOR SAFETY: Before tilting machine, turn the main power switch to the off position and empty tanks.

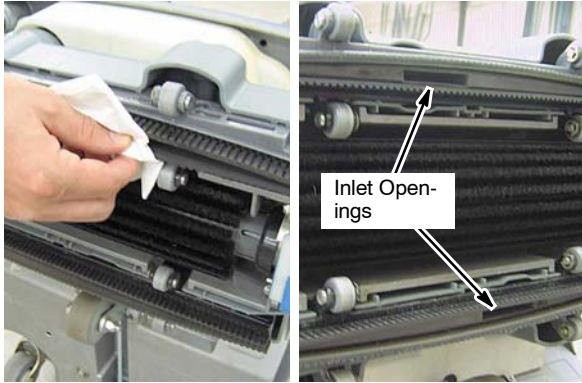

FIG. 33

- Clean the machine with an all purpose cleaner and damp cloth (Figure 34).

FOR SAFETY: When cleaning machine, do not power spray or hose off machine. Electrical malfunction may occur.



FIG. 34

- Clean the solution hose screen (Figure 35).



FIG. 35

VACUUM HOSE MAINTENANCE

To prevent debris buildup in vacuum system, flush vacuum hose as described below:

- Place machine over floor drain and turn the main power switch to the off position (Figure 36).



FIG. 36

- Place a dry towel over the vacuum intake screen to prevent water from entering vacuum motor (Figure 37).
- With water turned off, insert a garden hose into the vacuum intake hose as shown (Figure 38).

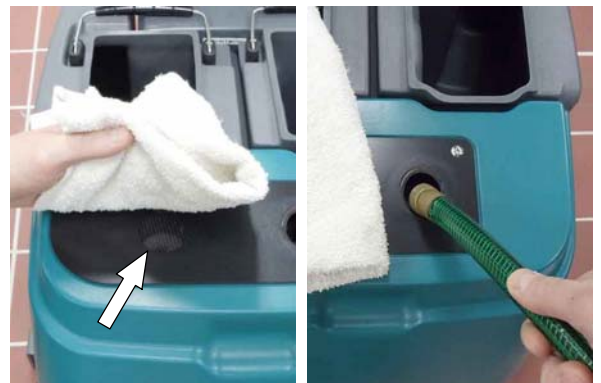

FIG. 37

FIG. 38

- Slowly turn on water to prevent back-splash if vacuum system is clogged. Increase water pressure to flush out debris buildup.

NOTE: The vacuum hose is Y-shaped. Make sure to flush out both sides (Figure 39).



FIG. 39

SQUEEGEE BLADE REPLACEMENT

Tilt the machine back to access the squeegee blades.

FOR SAFETY: Before tilting machine, turn the main power switch to the off position and empty tanks.

To remove the squeegee blades, lift the blade retainer clip and pull the blade from the channel (Figure 40).

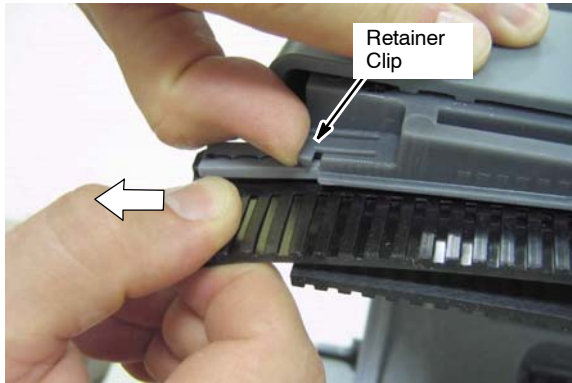

FIG. 40

For easy blade installation, the squeegee blades are color coded to match the scrub head blade channel (Figure 41).

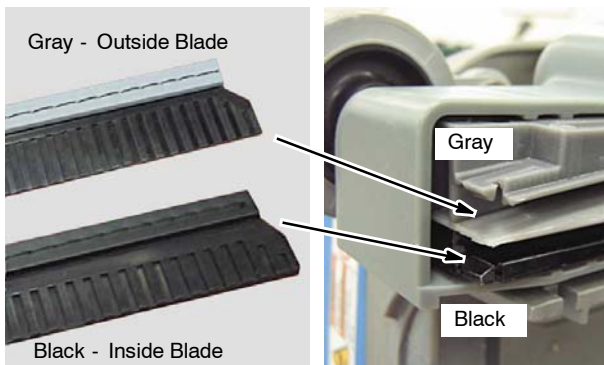

FIG. 41

To install blade, slide each blade into the appropriate channel until retainer clip engages blade (Figure 42). The squeegee blade ribs should face away from each other.



FIG. 42

TRANSPORTING MACHINE

Before transporting machine, empty water from tanks and turn the main power switch to the off position.

FOR SAFETY: When transporting machine, get assistance or use a mechanical lift when lifting machine.

FOR SAFETY: When transporting machine, use tie-down straps to secure machine.

To wheel machine from room to room, raise the scrub head to the transport position and push the machine forward (Figure 43).

DO NOT tilt machine on the rear wheels. Only use rear wheels to transport machine up and down a curb.



FIG. 43



FOR SAFETY: When transporting machine, do not tilt on rear wheels and do not wheel up or down stairs. Get assistance or use a mechanical lift when lifting machine.

STORING MACHINE

Before storing machine, empty tanks and fully charge the battery.

Store the machine in an open, well-ventilated, dry and clean area less than 45°C in the upright position.

Raise the scrub head to the transport position.

If storing machine in freezing temperatures, make sure to purge all water from solution system.

To purge water from solution system, empty solution tank, and operate the machine as normal for approximately 15 seconds.

⚠ WARNING: Electrical Shock Hazard. Do Not Use Outdoors. Do Not Expose To Rain/Moisture. Store Indoors.

TROUBLESHOOTING

PROBLEM	CAUSE	SOLUTION
Machine does not operate.	Discharged battery.	Charge battery.
	Charger plug is connected.	Disconnect charger plug.
	Defective battery.	Replace battery.
	Loose battery cable connection.	Tighten connections.
No vacuum	Vacuum switch not activated.	Turn on vacuum switch.
	Tripped vacuum circuit breaker.	Turn off main power switch. Remove obstruction and reset circuit breaker.
Poor solution pickup	Machine is in transport position.	Lower scrub head to floor.
	Recovery tank is full.	Empty recovery tank.
	Clogged squeegee blades or inlet openings.	Clean debris from squeegee blades and both inlet openings.
	Worn or damaged squeegee blades.	Replace squeegee blades.
	Clogged shut- off float.	Clean debris from shut- off float.
	Clogged vacuum intake screen.	Clean debris from intake screen.
	Worn tank cover gasket.	Contact Customer Service.
	Clogged vacuum hose.	Flush out debris buildup from vacuum hose. See MACHINE MAINTENANCE.
	Faulty vacuum motor.	Contact Customer Service.
Brush does not spin	Tripped brush circuit breaker.	Turn off main power switch. Remove obstruction from brush and reset circuit breaker.
	Broken brush belt.	Contact Customer Service.
	Faulty brush motor	Contact Customer Service.
Little or no solution spray.	Solution tank is empty.	Refill solution tank.
	Clogged solution tank screen	Clean solution tank screen.
	Clogged or defective spray tip.	Contact Customer Service.
	Faulty solution system.	Contact Customer Service.
Poor scrubbing performance.	Worn brush.	Replace brush.
Lithium- ion charger is blinking three green LEDs	Output plug not connected to machine.	Connect output plug securely.
AGM charger is blinking yellow		
Short battery run time	Battery not fully charged.	Charge battery.
	Charger AC cord not plugged into wall outlet.	Plug AC cord into wall outlet.
	Defective battery or charger.	Replace battery or charger.
	Defective charger plug.	Contact Customer Service.

MACHINE SPECIFICATIONS

MODEL	T1 Battery
LENGTH	695 mm with handle folded
WIDTH	502 mm
HEIGHT	594 mm with handle folded 965 mm with handle in working position
WEIGHT	50 kg with Lithium- ion battery 57 kg with AGM battery
SOLUTION TANK CAPACITY	9.5 L
RECOVERY TANK CAPACITY	12.9 L
PRODUCTIVITY RATE - AVG.	719 m ² /hr
CLEANING PATH WIDTH	381 mm
SQUEEGEE WIDTH	444 mm
BRUSH PRESSURE	17 kg
BRUSH MOTOR	12.8 VDC, .49 kW, 900 brush rpm
VACUUM MOTOR	12.8 VDC, .38 kW, 1- stage 5.7 in
WATER LIFT	305 mm Operating - 635 mm Sealed
SOLUTION PUMP	12.8 VDC, 11.9 W
SOLUTION FLOW RATE	0.38 L/min
BATTERY CAPACITY	12V Lithium- ion, 40Ah / 512Wh 12V AGM, 50Ah / 600Wh
MACHINE RUN TIME	60 min- Lithium- ion battery, 45 min - AGM Battery
VOLTAGE	12.8 VDC
TOTAL POWER CONSUMPTION	500W
BATTERY CHARGER (Supplied with AGM model)	220- 240 VAC, 2.4 A, 50 Hz, 14.6 VDC, 10 A output
BATTERY CHARGER (Supplied with Lithium- ion model)	220- 240 VAC, 2.4 A, 50 Hz, 14.6 VDC, 15 A output
DECIBEL RATING AT OPERATOR'S EAR, INDOORS LEVEL OF UNCERTAINTY	68 dBA 3 dBA
VIBRATIONS AT HAND CONTROLS	<2.5m/s ²
PROTECTION GRADE	IPX3

MACHINE DIMENSIONS

